



AUTOMOTIVE





MACHINE BLOCK WRENCH 17 X 24 MM

KUNCI BLOK MESIN 17 X 24 MM

- Material chrome vanadium
- Highly durable
- Easy to use
- Corrosion resistance

ITEM CODE	SIZE	1 (mm)	2 (mm)	3 (mm)	4 (mm)	5 (mm)	6 (mm)	7 (mm)	WEIGHT (gr)	QTY / DUS KECIL/BESAR
AU-MB0959	LURUS	235	24	17	41	35	25	6	255	6 / 60 pcs
AU-MB0960	BENGGOK	250	17	24	35	42	16	5	255	6 / 60 pcs

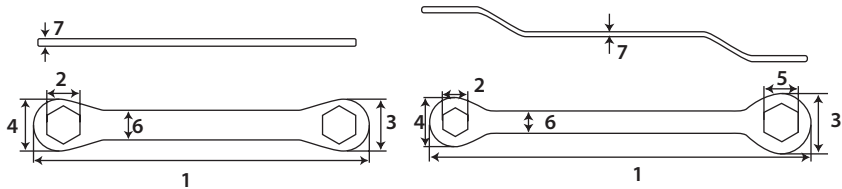

OIL FILTER WRENCH (CHAIN)

KUNCI OIL FILTER (RANTAI)

- Heat treated alloy steel
- Drop forged for extra strenght
- High quality powder coating finish

ITEM CODE	SIZE	1 (mm)	2 (mm)	3 (mm)	4 (mm)	5 (mm)	6 (mm)	WEIGHT (gr)	QTY / DUS KECIL/BESAR
AU-OF0961	6"	415	160	17	18	4	4	407	6 / 48 pcs
AU-OF0962	9"	500	230	24	21	5	9	419	6 / 48 pcs

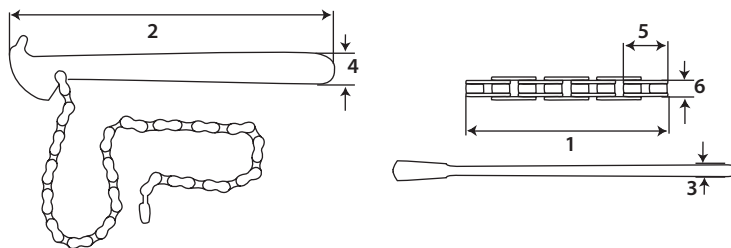

OIL FILTER WRENCH (BELT)

KUNCI OIL FILTER (KULIT)

- Heat treated alloy steel
- Drop forged for extra strenght
- High quality powder coating finish

ITEM CODE	SIZE	1 (mm)	2 (mm)	3 (mm)	4 (mm)	5 (mm)	6 (mm)	WEIGHT (gr)	QTY / DUS KECIL/BESAR
AU-OF0963	9"	520	229	10	20	23	19	310	12 / 72 pcs

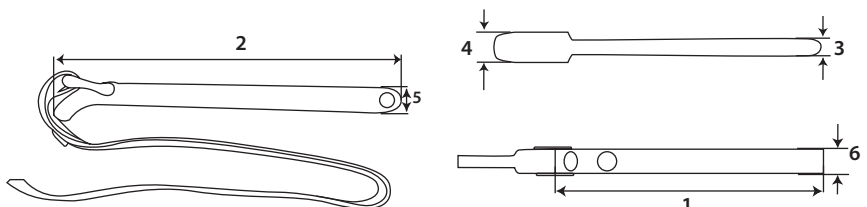



OIL FILTER (BOWL)

KUNCI OIL FILTER (MANGKOK)

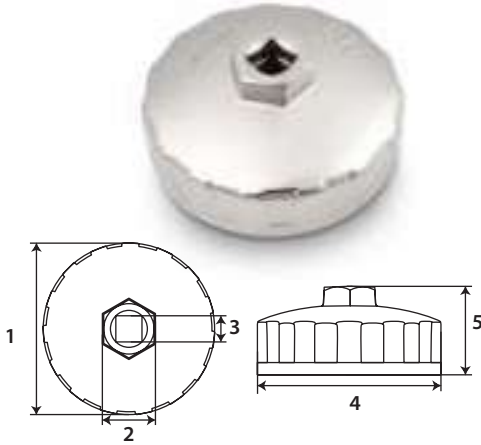

ITEM CODE	SIZE	1 (mm)	2 (mm)	3 (mm)	4 (mm)	5 (mm)	WEIGHT (gr)	QTY / DUS KECIL/BESAR
AU-OF0964	64 mm	72	26	26	72	35	77	12 / 100 pcs
AU-OF1468	66.5 mm	76	26	26	73	34	82	12 / 120 pcs
AU-OF1469	72.5 mm	78	26	26	78	36	80	12 / 120 pcs
AU-OF0965	74 mm	80	26	26	81	35	90	12 / 120 pcs
AU-OF0966	79 mm	79	26	26	85	42	109	12 / 120 pcs
AU-OF0967	89 mm	95	26	26	96	41	112	12 / 120 pcs
AU-OF0968	99 mm	106	26	26	106	46	138	12 / 120 pcs

Keterangan

- 64 mm = Avanza, CRV Lama, City
- 66.5 mm = Xenia
- 72.5 mm = Innova
- 74 mm = BMW, VW, Audi, Opel, Harley, Innova
- 79 mm = Kijang Kapsul, Taruna, Feroza, Ford
- 89 mm = Civic, Mitsubishi, Panther Lama
- 99 mm = Colt Diesel, Panther

2 WAY OIL FILTER

KUNCI OIL FILTER 2 ARAH

- Material Chrome Vanadium
- Remove and install Oil filter easily and quickly
- Hold the oil filter simply and firmly
- Suitable for 1/2" and 3/8" DR. Ratchet handle

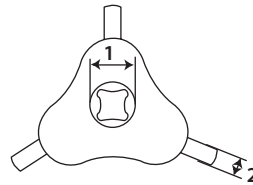

ITEM CODE	SIZE	1 (mm)	2 (mm)	WEIGHT (gr)	QTY / DUS KECIL/BESAR
AU-OF0969	63-102 mm	22	14	377	1 / 48 pcs

AUTO VOLTAGE TESTER



ITEM CODE	SIZE	WEIGHT (gr)	QTY / DUS KECIL/BESAR
AU-VT1061	DC	377	12 / 120 pcs

OIL CAN

- Flexible hose
- Ergonomic design
- Strong metal can



ITEM CODE	SIZE	1 (mm)	2 (mm)	3 (mm)	4 (mm)	WEIGHT (gr)	QTY / DUS KECIL/BESAR
AU-OC1414	500 ml	55	87	154	38	184	1 / 80 pcs

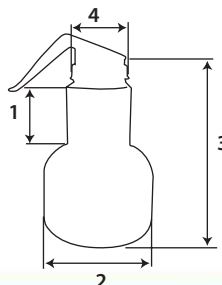



PISTON RING COMPRESSOR

• Material Chrome Vanadium



ITEM CODE	SIZE	1 (mm)	2 (mm)	3 (mm)	4 (mm)	WEIGHT (gr)	QTY / DUS KECIL/BESAR
AU-PC1446	3" X 57 - 125 mm	67	75	6	90	322	1 / 60 pcs
AU-PC1447	4" X 90 - 175 mm	69	110	6	90	294	1 / 60 pcs

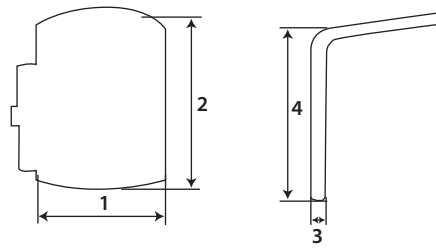

DRAIN PLUG WRENCH

KUNCI OLI GANDA

- Material Chrome Vanadium
- Heat treated Chrome vanadium steel
- Drop forged for extra strenght
- Silver matt finish



ITEM CODE	SIZE	1 (mm)	2 (mm)	3 (mm)	WEIGHT (gr)	QTY / DUS KECIL/BESAR
AU-DP0970	8 X 10 mm	280	8	10	347	12 / 60 pcs
AU-DP0971	10 X 10 mm	271	10	10	345	12 / 60 pcs

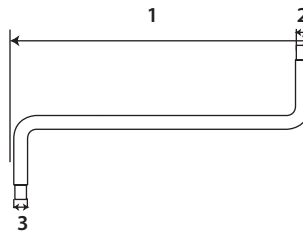

WHEEL NUT WRENCH (BLACK)

KUNCI RODA HITAM

- CRV head socket
- High durable rusty painting



ITEM CODE	SIZE	1 (mm)	2 (mm)	3 (mm)	4 (mm)	WEIGHT (gr)	QTY / DUS KECIL/BESAR
AU-WN0972	10 mm	255	71	10	12	326	6 / 48 pcs
AU-WN0973	12 mm	256	74	12	12	349	6 / 48 pcs
AU-WN0974	14 mm	245	78	14	13	358	6 / 48 pcs

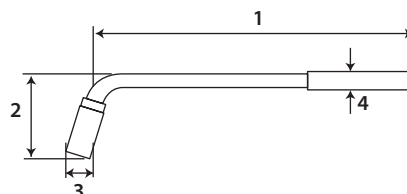



TEKIRO®
HAND TOOLS
BELIEVE IN YOUR CHOICE

www.tekiro.com



SCREWDRIIVER

AUTOMOTIVE

STORAGE

TRAY

WHEEL MASTER

KUNCI RODA TARIK

- Heavy duty and durable quality
- Telescopic handle for overstanding leverage
- Non-slip handgrip for comfortable holding



ITEM CODE	SIZE	1 (mm)	2 (mm)	3 (mm)	4 (mm)	5 (mm)	6 (mm)	WEIGHT (gr)	QTY / DUS KECIL/BESAR
AU-WM0975	19 X 21 mm	335	90	110	19	29	20	885	1 / 24 pcs

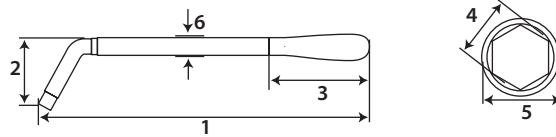

WHEEL NUT WRENCH FOR TRUCK

KUNCI RODA TRUK

- Molybdenum materials
- CRV head socket
- High durable rusty painting



ITEM CODE	SIZE	1 (mm)	2 (mm)	3 (mm)	4 (mm)	5 (mm)	WEIGHT (gr)	QTY / DUS KECIL/BESAR
AU-WN1461	20 X 38 X 440 mm	595	37	55	435	37	3,454	8 pcs
AU-WN1462	21 X 41 X 440 mm	595	39	39	440	39	3,844	8 pcs

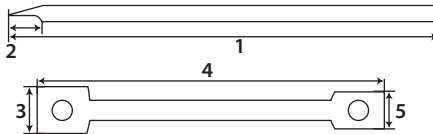

4 WAY CROSS WRENCH 14"

KUNCI RODA PALANG 14"

- CRV head socket
- High durable rusty painting



ITEM CODE	SIZE	1 (mm)	2 (mm)	3 (mm)	4 (mm)	WEIGHT (gr)	QTY / DUS KECIL/BESAR
AU-WC1463	17 X 19 X 21 X 23 mm	353	23	26 - 28 - 30 - 30	35	1,204	1 / 10 pcs

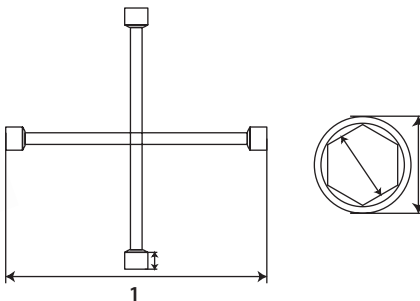

4 WAY WHEEL CROSS WRENCH

KUNCI RODA PALANG - MODEL LIPAT



ITEM CODE	SIZE	1 (mm)	2 (mm)	3 (mm)	4 (mm)	WEIGHT (gr)	QTY / DUS KECIL/BESAR
WR-WC0278	17 X 19 X 21 X 23 mm	40			34	1,204	1 / 12 pcs



SCREWDRIVER
AUTOMOTIVE
STORAGE
TRAY

WHEEL NUT WRENCH

KUNCI RODA L

- Material Chrome Vanadium
- CRV head socket
- High durable rusty painting



ITEM CODE	SIZE	1 (mm)	2 (mm)	3 (mm)	4 (mm)	5 (mm)	6 (mm)	WEIGHT (gr)	QTY / DUS KECIL/BESAR
AU-WN0976	19 mm	298	95	27	20	28	15	529	12 / 24 pcs
AU-WN0977	21 mm	300	95	27	21	30	15	510	12 / 24 pcs

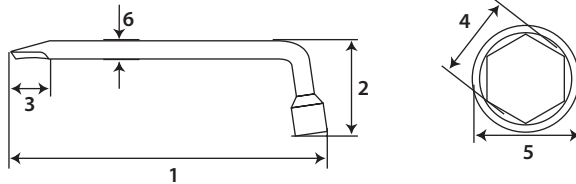

FEELER GAUGE

- Material Chrome Vanadium
- Complete range size
- Longer leaves allow accurate measuring



ITEM CODE	SIZE	1 (mm)	2 (mm)	3 (mm)	4 (mm)	5 (mm)	6 (mm)	WEIGHT (gr)	QTY / DUS KECIL/BESAR
AU-FG1292	13 blades	106	13	8	100	14	16	57	1 / 120 pcs

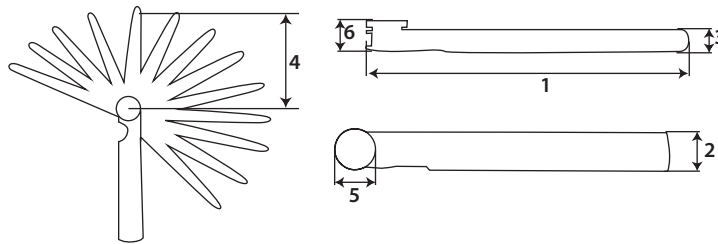

FEELER GAUGE ROLL

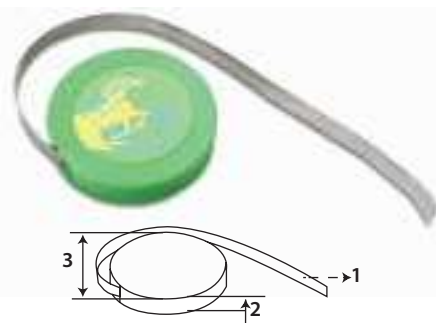

ITEM CODE	SIZE	1 (mm)	2 (mm)	3 (mm)	WEIGHT (gr)	QTY / DUS KECIL/BESAR
AU-FG1293	0.02 MM X 13 X 5	5,000	18	94	40	1 / 100 pcs
AU-FG1294	0.03 MM X 13 X 5	5,000	18	94	47	1 / 100 pcs
AU-FG1295	0.04 MM X 13 X 5	5,000	18	94	51	1 / 100 pcs
AU-FG1296	0.05 MM X 13 X 5	5,000	18	94	60	1 / 100 pcs
AU-FG1297	0.06 MM X 13 X 5	5,000	18	94	61	1 / 100 pcs
AU-FG1298	0.07 MM X 13 X 5	5,000	18	94	65	1 / 100 pcs
AU-FG1299	0.08 MM X 13 X 5	5,000	18	94	70	1 / 100 pcs
AU-FG1300	0.09 MM X 13 X 5	5,000	18	94	61	1 / 100 pcs
AU-FG1301	0.10 MM X 13 X 5	5,000	18	94	85	1 / 100 pcs

TIRE GAUGE (SMALL)

UKURAN TEKANAN ANGIN (KECIL)

- Material Chrome Vanadium



ITEM CODE	SIZE	1 (mm)	2 (mm)	3 (mm)	4 (mm)	WEIGHT (gr)	QTY / DUS KECIL/BESAR
AU-TG0980	60 lb	220	142	10	8	38	50 / 250 pcs
AU-TG0981	120 lb	220	142	10	8	40	50 / 250 pcs

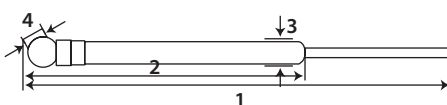



TIRE GAUGE (BIG)

UKURAN TEKANAN ANGIN (BESAR)

- Material Chrome Vanadium



ITEM CODE	SIZE	1 (mm)	2 (mm)	3 (mm)	4 (mm)	5 (mm)	6 (mm)	7 (mm)	WEIGHT (gr)	QTY / DUS KECIL/BESAR
AU-TG0982	# 7 (160 psi)	272	10	27	14	8	372	15	120	10 / 100 pcs
AU-TG0983	# 9 (200 psi)	272	10	27	14	8	372	15	140	10 / 100 pcs

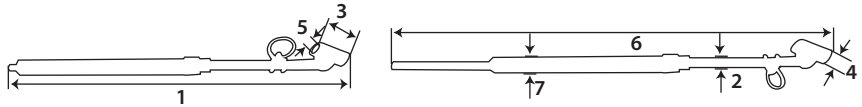

AIR CHUCK 6"

ISI ANGIN (KECIL)

- Material Chrome Vanadium
- Dual head pump up
- Hanging hole design
- Air inflow enlarge



ITEM CODE	SIZE	1 (mm)	2 (mm)	3 (mm)	WEIGHT (gr)	QTY / DUS KECIL/BESAR
AU-AC0984	Chrome 6"	170	9	15	115	10 / 100 pcs

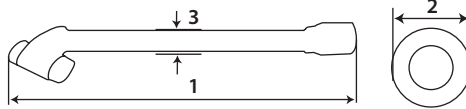

TUNE UP KIT 5 PCS

ITEM CODE
5 PCS
AU-TU1060

- Flexible ratchet handle for flexible working
- Extension bar to reach deep position
- High corrosion resistance

SIZE	CONTENT	WEIGHT (gr)	QTY / DUS KECIL/BESAR
5 pcs	1 pcs 3/8" DR. Ratchet Handle Flexible	940	1 / 20 set
	1 pcs 3/8" Spark Plug Socket 16 mm		
	1 pcs 3/8" Spark Plug Socket 21 mm		
	1 pcs 3/8" DR. Extension Bar 5"		
	1 pcs 3/8" DR. Extension Bar 8"		



TIRE PRESSURE GAUGE 3 IN 1

ISI ANGIN 3 FUNGSI

- Ergonomic handle
- Flexible & high pressure hose
- Material Chrome vanadium



ITEM CODE	SIZE	1 (mm)	2 (mm)	3 (mm)	4 (mm)	5 (mm)	6 (mm)	WEIGHT (gr)	QTY / DUS KECIL/BESAR
AU-PG1405	200 psi	125	11	75	13	12	515	450	1 / 40 pcs

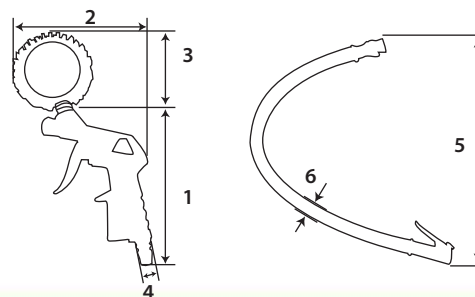



PRESSURE GAUGE

UKURAN TEKANAN 2.5"

- Double standard air pressure
- Glass cover



ITEM CODE	SIZE	1 (mm)	2 (mm)	3 (mm)	WEIGHT (gr)	QTY / DUS KECIL/BESAR
AU-PG1395	2.5 bar	61	26	12	109	10 / 100 pcs
AU-PG0986	4 bar	61	28	13	120	10 / 100 pcs
AU-PG0987	6 bar	61	28	13	120	10 / 100 pcs
AU-PG0988	10 bar	61	28	13	120	10 / 100 pcs
AU-PG0989	16 bar	61	28	13	120	10 / 100 pcs
AU-PG0990	25 bar	61	28	13	120	10 / 100 pcs

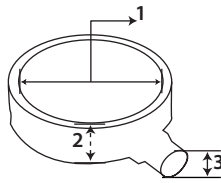

TIRE GAUGE FOR TRUCK

ISI ANGIN 3 FUNGSI (TRUK)

ITEM CODE	SIZE	1 (mm)	2 (mm)	3 (mm)	4 (mm)	5 (mm)	6 (mm)	WEIGHT (gr)	QTY / DUS KECIL/BESAR
AU-TG0992	220 psi	183	73	75	13	14	851	761	1 / 9 pcs



AIR CHUCK FOR TRUCK

ISI ANGIN (BESAR)

- Material Chrome Vanadium

ITEM CODE	SIZE	1 (mm)	2 (mm)	3 (mm)	4 (mm)	5 (mm)	WEIGHT (gr)	QTY / DUS KECIL/BESAR
AU-AC0993	12"	350	9	15	85	15	106	1 / 100 pcs

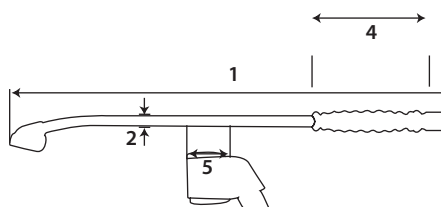



HYDRAULIC FLOOR JACK WITH CASE 2 TON SPEC #2
DONGKRAK BUAYA 2 TON SPEC #2

- 360° rotating lifting handle
- Maximal lifting height : 342mm
- Safety valve to ensure the safety



ITEM CODE	SIZE	1 (mm)	2 (mm)	3 (mm)	4 (mm)	5 (mm)	6 (mm)	WEIGHT (gr)	QTY / DUS KECIL/BESAR
AU-FJ0994	2 ton	440	200	135	52	135 - 335	458	8,177	1 pcs

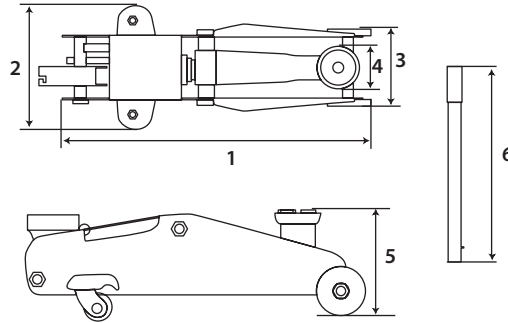

FLOOR JACK TYPE ROTARY
DONGKRAK BUAYA PUTAR



ITEM CODE	SIZE	1 (mm)	2 (mm)	3 (mm)	4 (mm)	5 (mm)	6 (mm)	WEIGHT (gr)	QTY / DUS KECIL/BESAR
AU-FJ0995	2 ton	440	200	135	52	135 - 335	458	8,274	1 pcs

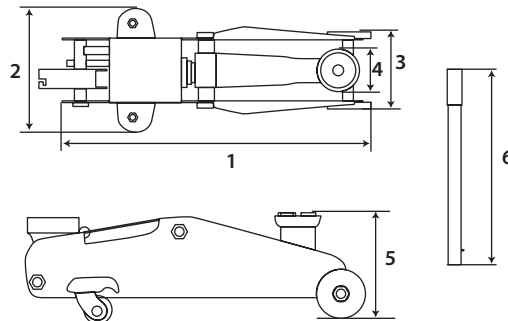

HEAVY DUTY HYDRAULIC FLOOR JACK
DONGKRAK BUAYA PANJANG

- Wide bowl for stability
- Foot pump for high speed lifting
- Safety valve to prevent Over load



ITEM CODE	SIZE	1 (mm)	2 (mm)	3 (mm)	4 (mm)	5 (mm)	6 (mm)	7 (mm)	WEIGHT (gr)	QTY / DUS KECIL/BESAR
AU-FJ0997	3 ton	1,140	300	235	78	300	110	89	34,000	1 pcs
AU-FJ0998	5 ton	1,301	360	270	130	300	110	109	87,000	1 pcs
AU-FJ0999	10 ton	1,360	480	320	180	370	170	141	133,000	1 pcs

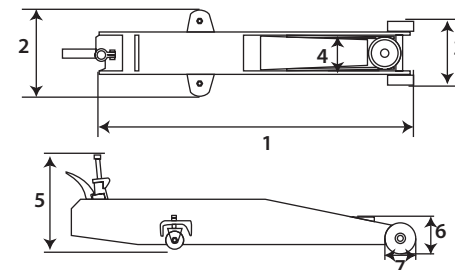



SCISSOR JACK AUTOMOTIVE

DONGKRAK JEMBATAN 2 TON

- Thread rod is integral rod
- Arms have teeth design increase stabilization
- Handle is riveted together can be folded, easy to carry

ITEM CODE	SIZE	1 (mm)	2 (mm)	3 (mm)	4 (mm)	5 (mm)	6 (mm)	WEIGHT (gr)	QTY / DUS KECIL/BESAR
AU-SJ1059	2 ton	440	68	165	29	60	560	3,360	1 pcs

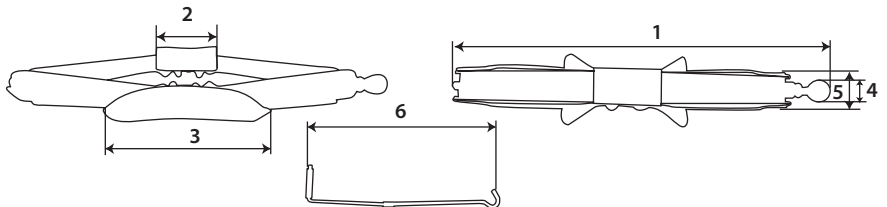

HYDRAULIC FLOOR JACK WITH FOOT PUMP 3 TON

DONGKRAK BUAYA 3 TON (PENDEK)

- Wide bowl for stability
- Foot pump for high speed lifting
- Safety valve to prevent over load

ITEM CODE	SIZE	1 (mm)	2 (mm)	3 (mm)	4 (mm)	5 (mm)	6 (mm)	WEIGHT (gr)	QTY / DUS KECIL/BESAR
AU-FJ0996	3 ton	590	345	263	121	135 - 495	270	34,000	1 pcs

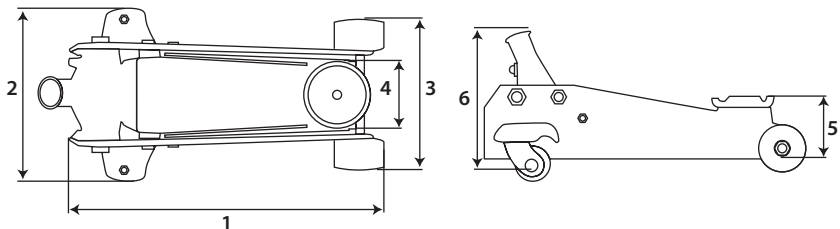

ALUMINUM FLOOR JACK

DONGKRAK BUAYA ALUMINIUM

ITEM CODE	SIZE	1 (mm)	2 (mm)	3 (mm)	4 (mm)	5 (mm)	6 (mm)	WEIGHT (gr)	QTY / DUS KECIL/BESAR
AU-FJ1000	3000 LBS (1.5 Ton)	510	240	135	100	200	83	11,200	1 pcs

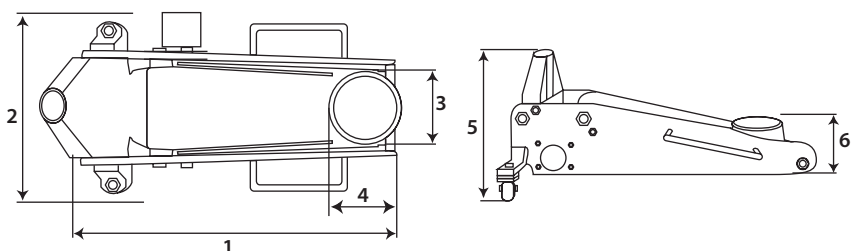



HYDRAULIC BOTTLE JACK
DONGKRAK BOTOL



ITEM CODE	SIZE	1 (mm)	2 (mm)	3 (mm)	4 (mm)	5 (mm)	6 (mm)	7 (mm)	WEIGHT (gr)	QTY / DUS KECIL/BESAR
AU-BJ1001	2 ton	355	126	185	15	23	51	7	2,400	1 / 6 pcs
AU-BJ1002	4 ton	390	132	199	19	28	60	8	3,130	1 / 6 pcs
AU-BJ1003	6 ton	450	152	220	23	32	70	9	4,500	1 / 4 pcs
AU-BJ1004	10 ton	475	165	235	27	40	80	9	6,800	1 / 4 pcs
AU-BJ1005	15 ton	475	161	245	32	48	95	9	8,300	1 / 2 pcs
AU-BJ1006	20 ton	475	170	254	35	53	114	10	11,000	1 / 2 pcs
AU-BJ1007	30 ton	485	200	285	50	67	136	44	21,480	1 pcs
AU-BJ1008	50 ton	500	200	300	70	82	158	44	31,960	1 pcs
AU-BJ1009	100 ton	540	215	325	100	115	230	55	87,000	1 pcs

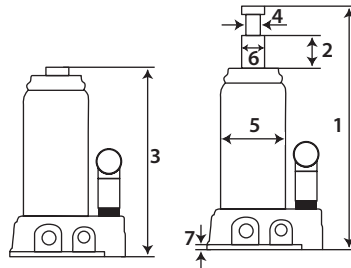

JACK STAND
TAHANAN DONGKRAK

- Large feet area & large saddle for stabilization
- double locking protection for safety



ITEM CODE	SIZE	1 (mm)	2 (mm)	3 (mm)	4 (mm)	5 (mm)	6 (mm)	7 (mm)	WEIGHT (gr)	QTY / DUS KECIL/BESAR
AU-JS1010	3 ton	288	423	210	64	270	35	26	6,930	1 / 4 pcs
AU-JS1011	6 ton	400	615	290	70	365	40	29	130,003	1 pcs

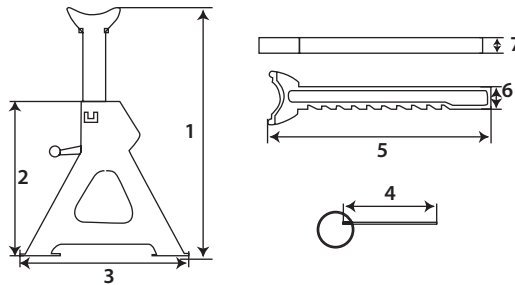

HAND GREASE GUN
POMPA GEMUK - TANGAN

- High pressure flexible hose
- Very high pressure steel tube



ITEM CODE	SIZE	1 (mm)	2 (mm)	3 (mm)	4 (mm)	5 (mm)	6 (mm)	WEIGHT (gr)	QTY / DUS KECIL/BESAR
AU-GG1015	500 cc	379	58	17	266	68	90	1,501	12 pcs

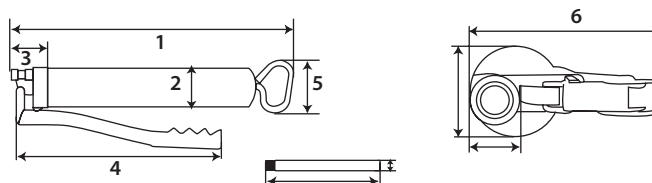



MINI GREASE GUN

POMPA GEMUK MINI TANGAN

- Small size, high pressure
- Special coupler



ITEM CODE	SIZE	1 (mm)	2 (mm)	3 (mm)	4 (mm)	5 (mm)	6 (mm)	7 (mm)	WEIGHT (gr)	QTY / DUS KECIL/BESAR
AU-GG1014	100 cc	217	32	45	182	59	36	15	454	1 / 36 pcs

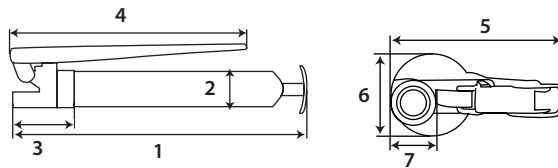

SET HOSE HAND GREASE GUN 6 PCS

SET 6 PCS SELANG POMPA GEMUK - TANGAN

- 1/2" Flexible hose 4500 psi
- 4 jaws coupler to fit strongly



ITEM CODE	SIZE	1 (mm)	2 (mm)	3 (mm)	4 (mm)	5 (mm)	6 (mm)	WEIGHT (gr)	QTY / DUS KECIL/BESAR
AU-HG1369	6 PCS	330	31	9	7	13	40	549	6 pcs

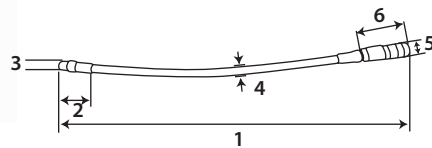

HAND GREASE PUMP

POMPA GEMUK - DRUM

- Wheel and handle for easy handling
- Ergonomic pump handle
- Flexible hose and gun for easy use



ITEM CODE	SIZE	1 (mm)	2 (mm)	3 (mm)	4 (mm)	5 (mm)	6 (mm)	7 (mm)	WEIGHT (gr)	QTY / DUS KECIL/BESAR
AU-GP1012	20 L	780	295	440	150	430	16	1,470	10,000	1 pcs

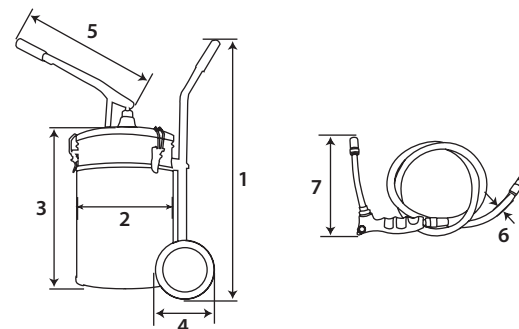



TEKIRO®

HAND TOOLS
BELIEVE IN YOUR CHOICE

www.tekiro.com



SCREWDRIVER

AUTOMOTIVE

STORAGE

TRAY

HAND OIL PUMP

POMPA OLI - DRUM

- Big volume storage tank
- Easy to re - fill the oil



ITEM CODE	SIZE	1 (mm)	2 (mm)	3 (mm)	4 (mm)	5 (mm)	6 (mm)	7 (mm)	WEIGHT (gr)	QTY / DUS KECIL/BESAR
AU-OP1013	20 L	780	295	440	150	430	18	1,500	800	1 pcs

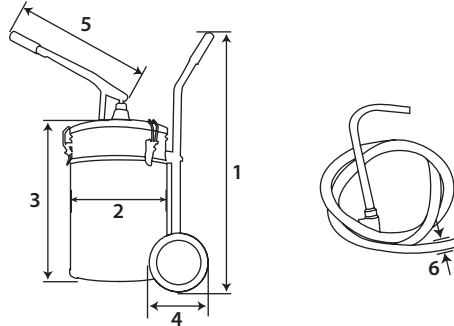

OIL SUCTION GUN

POMPA OLI - TANGAN

- Deluxe lip seal for maximum suction
- 12° Flexible delivery tube



ITEM CODE	SIZE	1 (mm)	2 (mm)	3 (mm)	4 (mm)	5 (mm)	6 (mm)	7 (mm)	WEIGHT (gr)	QTY / DUS KECIL/BESAR
AU-SG1016	500 cc	289	60	55	245	318	34	14	148	1 / 20 pcs
AU-SG1291	1,000 cc	400	60	50	245	335	32	13	1,078	1 / 12 pcs

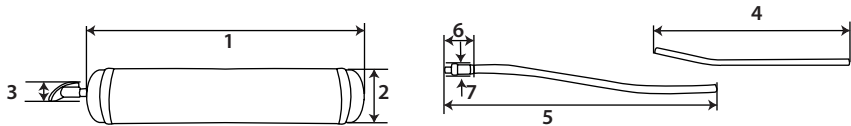

RIM CROWBAR

CONGKELAN BAN

- Material chrome vanadium



ITEM CODE	SIZE	1 (mm)	2 (mm)	WEIGHT (gr)	QTY / DUS KECIL/BESAR
AU-RC1017	10"	254	19	193	12 / 120 pcs
AU-RC1018	12"	300	22	195	12 / 96 pcs

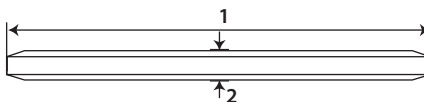



MAGNETIC TRACKER

TREKER MAGNET

- The product made by high quality material of CRMO SKS within high torque strength for professional using
- Adjustable angle fixed jaws have convenience working easily
- Easy simple action to change the jaws be inside or outside working



ITEM CODE	SIZE	1 (mm)	2 (mm)	3 (mm)	4 (mm)	5 (mm)	6 (mm)	WEIGHT (gr)	QTY / DUS KECIL/BESAR
AU-MT1020	GL	158	110	15	37	9	36	386	1 / 36 pcs
AU-MT1024	KN	121	111	16	37	9	36	415	1 / 36 pcs

Keterangan

GL = HONDA GL - PRO
KN = KAWASAKI NINJA

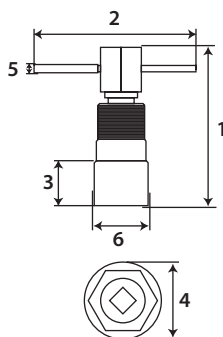

MAGNETIC TRACKER MULTI FUNCTION

TREKER MAGNET MULTI FUNGSI

- Material Chrome Vanadium
- Design to magnetic uninstall
- Simple structure and easy to use
- High durable and corrosion resistance

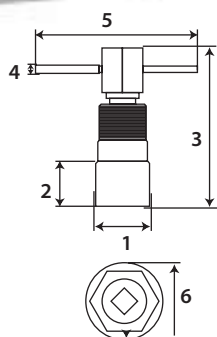

ITEM CODE	SIZE	1 (mm)	2 (mm)	3 (mm)	4 (mm)	5 (mm)	6 (mm)	WEIGHT (gr)	QTY / DUS KECIL/BESAR
AU-MT1030	NO 1	34	34	92	8	118	33	394	1 / 40 pcs
AU-MT1031	NO 2	34	34	92	8	118	33	388	1 / 40 pcs
AU-MT1032	NO 3	36	28	91	9	119	36	391	1 / 40 pcs
AU-MT1033	NO 4	31	50	102	9	119	31	450	1 / 40 pcs

Keterangan

NO 1 = Honda (Kharisma, NSR, Tiger), Kawasaki (Ninja), Yamaha (RX), Suzuki (Satria, RC, Thunder 125)
NO 2 = Honda (C7--, KC, GL, Grand, Tiger), Yamaha (RX-K, RX-S, RX-Z, Mio, Nouvo), Suzuki (GTO, RS, RGR, Satria F 150, Shogun)
NO 3 = Yamaha (Alfa, Champ, Force 1)
NO 4 = Honda (Neotech, Toger), Suzuki (RC), Yamaha (RX)

MECHANIC CREEPER

ITEM CODE	SIZE	1 (mm)	2 (mm)	3 (mm)	4 (mm)	5 (mm)	6 (mm)	7 (mm)	WEIGHT (gr)	QTY / DUS KECIL/BESAR
AU-MC1019	100 X 46 cm	1,000	470	200	85	450	25	47	4,900	1 pcs

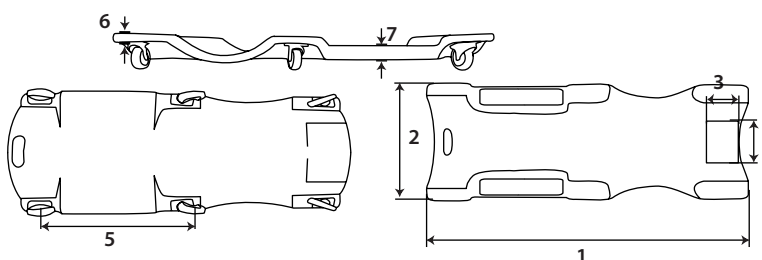



DISC BRAKE SPREADER

TREKER REM MOBIL

- Suitable for use on all vehicle types and models
- Easily and quickly separates pistons in their calipers
- Simple on-hand installation



ITEM CODE	SIZE	1 (mm)	2 (mm)	3 (mm)	4 (mm)	5 (mm)	6 (mm)	WEIGHT (gr)	QTY / DUS KECIL/BESAR
AU-DB1034	15.2 X 7.3 X 2.1 cm	153	114	9	5	6	12	750	1 / 24 pcs

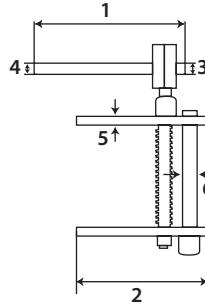

BALL JOINT SEPARATOR

TREKER BALL JOINT



ITEM CODE	SIZE	1 (mm)	2 (mm)	3 (mm)	WEIGHT (gr)	QTY / DUS KECIL/BESAR
AU-BJ1036	9"	159	92	31	1,270	1 / 20 pcs

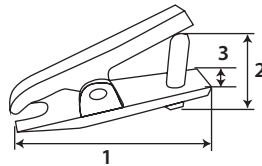

FLANGE AXLE PULLER

TREKER KAKI BEBEK

- Material chrome vanadium



ITEM CODE	SIZE	1 (mm)	2 (mm)	3 (mm)	4 (mm)	WEIGHT (gr)	QTY / DUS KECIL/BESAR
AU-AP1037	59 X 18 cm	576	380	15	82	4,118	1 / 24 pcs

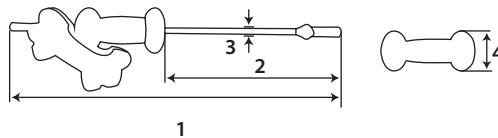

COIL SPRING COMPRESSOR (SINGLE)

TREKER PER MOBIL - SINGLE

- Design for suitable use when arch is limited
- High safety when working in high-tension springs
- Jaw design is fitting to wrap coil claws for safety



ITEM CODE	SIZE	1 (mm)	2 (mm)	3 (mm)	WEIGHT (gr)	QTY / DUS KECIL/BESAR
AU-CS1038	400 mm	450	32	20	2,160	1 dus @ 10 set

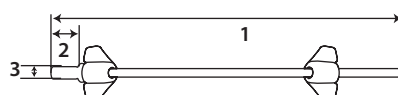



COIL SPRING CLAMP (DOUBLE)

TREKER PER MOBIL - DOUBLE

- Design for suitable use when wheel arch is limited
- High safety when working on high-tension spring
- Jaw design is fitting to warp coil claws for safety



ITEM CODE	SIZE	1 (mm)	2 (mm)	3 (mm)	WEIGHT (gr)	QTY / DUS KECIL/BESAR
AU-CS1039	400 mm	451	31	21	2254	1 dus @ 10 set

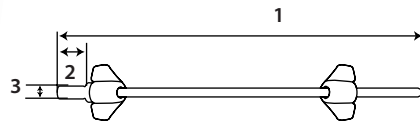

UNIVERSAL HOLDER

TAHANAN KOPLING

- Material Chrome Vanadium



ITEM CODE	SIZE	1 (mm)	2 (mm)	3 (mm)	4 (mm)	WEIGHT (gr)	QTY / DUS KECIL/BESAR
AU-UH1040	33 X 22 cm	330	123	64	19	481	3 box @ 12 pcs

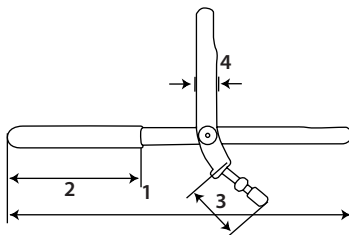

CLUTCH SPRING CHECK TOOL

TAHANAN RUMAH KOPLING MOTOR MATIC

- Material Chrome Molybdenum



ITEM CODE	SIZE	1 (mm)	2 (mm)	3 (mm)	4 (mm)	5 (mm)	6 (mm)	WEIGHT (gr)	QTY / DUS KECIL/BESAR
AU-CP1041	125 - 155 mm	135	20	109	167	83	35	1,470	24 pcs

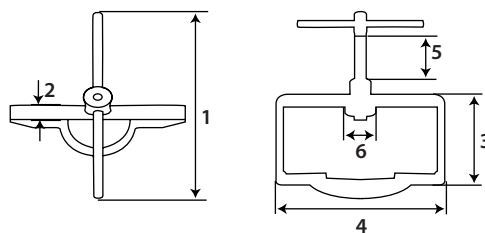

PULLEY HOLDER 8 PCS (CRANKASE/CRANKSHAFT)

TREKER RUMAH MESIN MOTOR

- Material Chrome Molybdenum



ITEM CODE	SIZE	WEIGHT (gr)	QTY / DUS KECIL/BESAR
AU-CR1042	8 pcs	1,500	12 pcs



HEAVY DUTY VALVE SPRING COMPRESSOR

TREKER KLEP MOBIL

- Material Chrome Molybdenum
- Specifically for small Engine applications
- Easily for replacing valve spring
- Suitable for different valve size



ITEM CODE	SIZE	1 (mm)	2 (mm)	3 (mm)	4 (mm)	5 (mm)	6 (mm)	WEIGHT (gr)	QTY / DUS KECIL/BESAR
AU-SC1043	19 mm ~ 16.5 mm	47	244	108	25	130	50	1,235	1 dus @ 12 set
	23 mm ~ 21.5 mm	47	244	108	25	130	50	1,235	1 dus @ 12 set
	25 mm ~ 23.5 mm	47	244	108	25	130	50	1,235	1 dus @ 12 set

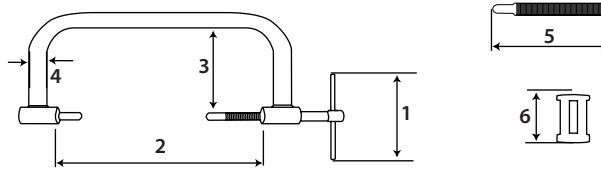

BEARING PULLER

TREKER BEARING

- Easy to remove bearings
- Fully adjustable jaws
- Suitable for multiple bearings
- Molybdenum materials



ITEM CODE	SIZE	1 (mm)	2 (mm)	3 (mm)	4 (mm)	WEIGHT (gr)	QTY / DUS KECIL/BESAR
AU-BP1044	AB 1	87	56	70	54	280	10 / 50 pcs
AU-BP1045	AB 2	107	83	131	78	677	10 / 30 pcs

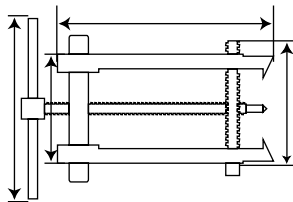

TWO ARM PULLER

TREKER KAKI 2

- Material Chrome Vanadium



ITEM CODE	SIZE	1 (mm)	2 (mm)	3 (mm)	4 (mm)	WEIGHT (gr)	QTY / DUS KECIL/BESAR
AU-AP1047	3"	100	75	10	6	227	1 / 60 pcs
AU-AP1048	4"	123	100	13	8	360	1 / 50 pcs
AU-AP1049	6"	171	150	17	10	810	1 / 30 pcs
AU-AP1050	8"	245	200	18	12	1,900	1 / 12 pcs
AU-AP1051	10"	325	250	25	18	3,700	1 / 6 pcs
AU-AP1052	12"	360	300	29	22	5,880	1 / 4 pcs

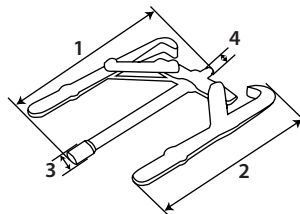



THREE ARM PULLER

TREKER KAKI 3

• Material Chrome Vanadium



ITEM CODE	SIZE	1 (mm)	2 (mm)	3 (mm)	4 (mm)	WEIGHT (gr)	QTY / DUS KECIL/BESAR
AU-AP1053	3"	100	75	11	7	320	1 / 60 pcs
AU-AP1054	4"	123	100	13	8	485	1 / 40 pcs
AU-AP1055	6"	171	150	17	10	1,100	1 / 20 pcs
AU-AP1056	8"	245	200	19	13	2,600	1 / 8 pcs
AU-AP1057	10"	320	250	25	18	4,980	1 / 4 pcs
AU-AP1058	12"	360	300	29	23	7,500	1 / 3 pcs

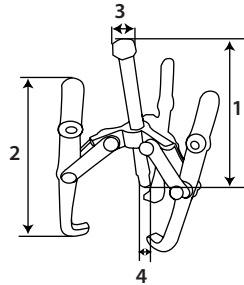

ALL IN ONE GEAR PULLER

• Material Chrome Molybdenum



ITEM CODE	SIZE	WEIGHT (gr)	QTY / DUS KECIL/BESAR
AU-GP1035	220 X 133 X 17 X 17 X 12 mm	1,600	1 / 10 pcs



CHAIN REMOVER

PEMOTONG RANTAI

- Easy to disconnect roller chain
- Metal body for highly durable
- Suitable for motorcycle and bicycle chain



ITEM CODE	SIZE	1 (mm)	2 (mm)	3 (mm)	4 (mm)	WEIGHT (gr)	QTY / DUS KECIL/BESAR
AU-CR1046	25 - 60	63	98	44	135	280	1 / 50 pcs

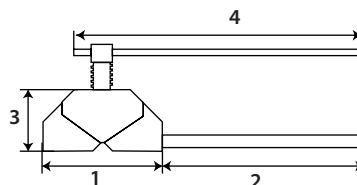



BEARING SEPARATOR SET



ITEM CODE	CONTENT	WEIGHT (gr)	QTY / DUS KECIL/BESAR
AU-SS1402	2 pcs Bearing Separator Capacity 30 x 50 mm (1 1/4" - 2 1/2") Capacity 50 x 75 mm (2 1/4" - 3 1/2")	4,690	1 / 5 set
	2 pcs 17 X L127 mm Extention Screw (Male & Female Threads)		
	2 pcs 17 X L127 mm Extention Screw (Male Threads)		
	2 pcs 17 X L103 mm Extention Screw (Male & Female Threads)		
	2 pcs 17 X L103 mm Extention Screw (Male Threads)		
	1 pcs 6" Bar - Type Puller Yoke		
	1 pcs Forcing Screw 9/16" X L175 mm		

FLANGE AXLE AND JAW PULLER SET



ITEM CODE	CONTENT	WEIGHT (gr)	QTY / DUS KECIL/BESAR
AU-UA1403	3 pcs Internal / External Puller Jaws	7,697	1 / 2 set
	3 pcs Screws and Nuts		
	2 pcs Flange Axle Puller (Shallow & Deep)		
	1 pcs Heavy - Duty Slide Hammer		
	1 pcs Center Bolt And T - Bar		
	1 pcs 2 - Way Puller Cross Head		
	1 pcs 3 - Way Puller Cross Head		
	1 pcs Jaw Spreader Cone		
	1 pcs Puller Hook Adapter		
	1 pcs Locking Plier Adapter		
	1 pcs Dent Puller Screw Adapter		
	1 pcs Tapping Screw		
	1 pcs Forcing Screw 5/8" x L145 mm		



MECHANIC TOOLS 45 PCS
AUTOMOTIVE TOOL SET (BESI)

ITEM CODE
45 PCS
AU-MT0978



SIZE	CONTENT	WEIGHT (gr)	QTY / DUS KECIL/BESAR
45 pcs	9 pcs Socket 10 mm, 12 mm, 13 mm, 14 mm, 17 mm 19 mm, 21 mm, 22 mm, 24 mm	8,751	1 set
	1 pcs 1/2" DR. Spark Plug 21 mm		
	1 pcs 1/2" DR. Flexble Handle 15"		
	1 pcs 1/2" DR. Ratchet Handle 72 Teeth Rubber Handle 10"		
	1 pcs 1/2" DR. Extention Bar 5"		
	1 pcs Diagonal Plier 6"		
	1 pcs Long Nose Plier 6"		
	1 pcs Slip Joint Pliers 8"		
	1 pcs Water Pump Pliers 10"		
	1 pcs Ballpien Hammer 6 OZ		
	6 pcs Open End Wrench 8 X 9 mm, 10 X 11 mm, 12 X 13 mm 12 X 14 mm, 14 X 17 mm, 17 X 19 mm		
	6 pcs Boxes End Wrench 10 X 11 mm, 12 X 13 mm, 12 X 14 mm 14 X 17 mm, 19 X 21 mm, 22 X 24 mm		
	11 pcs Go-Thru Screwdriver (+) PH0 X 75 mm (3.2) (+) PH1 X 75 mm (5) (+) PH2 X 38 mm (6) (+) PH2 X 100 mm (6) (+) PH3 X 150 mm (8) (-) 3.2 X 75 mm, (-) 5 X 75 mm (-) 6 X 38 mm, (-) 6 X 100 mm (-) 8 X 150 mm, (-) 8 X 200 mm		
	1 pcs Adjustable Wrench 8"		
	1 pcs Adjustable Wrench 12"		
	1 pcs Kikir		
	1 pcs Metal Case		

SCREWDRIVER

AUTOMOTIVE

STORAGE

TRAY



TEKIRO®

HAND TOOLS
BELIEVE IN YOUR CHOICE

www.tekiro.com



SCREWDRIVER

AUTOMOTIVE

STORAGE

TRAY

ITEM CODE
59 PCS
AU-MT0979



MECHANIC TOOLS 59 PCS

YAMAHA TOOL KIT (BESI)

SIZE	CONTENT	WEIGHT (gr)	QTY / DUS KECIL/BESAR
59 pcs	5 pcs Open end wrench 6 X 7 mm, 8 X 10 mm, 12 X 14 mm 17 X 19 mm, 22 X 24 mm	9,376	1 set
	4 pcs Box End Wrench 8 X 10 mm, 12 X 14 mm 17 X 19 mm, 22 X 24 mm		
	10 pcs 3/8" DR. Socket 8 mm, 10 mm, 12 mm, 14 mm, 17 mm 19 mm, 21 mm, 22 mm, 23 mm, 24 mm		
	1 pcs 3/8" DR. Ratchet Handle 72 Teeth Rubber Handle 8"		
	1 pcs 3/8" DR. Sliding T Bar 8"		
	1 pcs 3/8" DR. Extension Bar 6"		
	2 pcs 3/8" DR. Spark Plug 16 mm, 21 mm		
	8 pcs Go-Thru Screw Driver (+) PH1 X 75 mm, (+) PH2 X 38 mm (+) PH2 X 100 mm (+) PH3 X 150 mm (-) 5 X 75 mm, (-) 6 X 38 mm (-) 6 X 100 mm, (-) 8 X 150 mm		
	1 pcs Slip Joint Plier 8"		
	1 pcs Long Nose Plier 6"		
	1 pcs Diagonal Plier 6"		
	1 pcs Snap Ring 7" IS		
	1 pcs Snap Ring 7" ES		
	1 pcs Adjustable Wrench 10"		
	1 pcs Ball Pein Hammer with Fibre 8 OZ		
	1 pcs Double Plastic Hammer 30 mm		
	8 pcs Hex Key Set 2-10 mm 2 mm, 2.5 mm, 3 mm, 4 mm 5 mm, 6 mm, 8 mm, 10 mm		
	1 set Impact Driver 11 pcs		
	1 pcs Plastic Handle Screwdriver (-) 3x 100 mm		
	1 pcs Feeler Gauge 13 Blades		
	1 pcs Scrapper		
	3 pcs T-Type Wrench Rubber Handle 8 mm, 10 mm, 12 mm		
	1 pcs Square Drive		
	1 pcs Metal Case		



MECHANIC TOOLS 50 PCS

HONDA TOOL KIT (BESI)

ITEM CODE	CONTENT	WEIGHT (gr)	QTY / DUS KECIL/BESAR
AU-TS1427	4 pcs Combination Wrench 10 mm, 12 mm, 14 mm, 17 mm		1 set
	6 pcs Open End Wrench 6 X 7 mm, 8 X 9 mm, 10 X 12 mm 12 X 14 mm, 14 X 17 mm, 17 X 19 mm		
	5 pcs Box End Wrench 8 X 9 mm, 10 X 12 mm, 12 X 14 mm 14 X 17 mm, 17 X 19 mm		
	1 pcs Snap Ring 7" IS		
	1 pcs Snap Ring 7" ES		
	1 pcs Linesman Plier 8"		
	1 pcs Long Nose Plier 8"		
	1 pcs Diagonal Plier 8"		
	1 pcs Ball Pein Hammer With Fibre 16 OZ		
	1 pcs Double Plastic Hammer 35 mm		
	1 pcs Cooper Hammer 500 Gr		
	3 pcs T-Type Wrench With Screwdriver (+) PH2, (+) PH3, (-) 8		
	6 pcs T-Type Wrench 8 mm, 9 mm, 10 mm, 12 mm, 14 mm, 17 mm		
	2 pcs T-Type Spark Plug 10 mm, 12 mm		
	1 pcs Wheel Nut Wrench 10 mm		
	1 pcs Feeler Gauge 13 Blades		
	1 pcs Engine Block Wrench Flat 17 X 24 mm		
	1 pcs Valve Adjustable Wrench		
	3 pcs Feeler Gauge Roll 0.03 mm X 13 X 5, 0.05 mm X 13 X 5 0.1 mm X 13 X 5		
	4 pcs 1/2" DR. Impact Socket 6 PT 10 mm, 12 mm, 14 mm, 17 mm		
	4 pcs T-Type Wrench Extra Long 500 mm X 8 mm, 500 mm X 10 mm, 500 mm X 12 mm, 500 mm X 14 mm		
	1 pcs Tool Box 3 Draw		